



## ITA

### Squadrette di giunzione

Per profili in alluminio con pulsanti di tiraggio a scatto.

## EN

### Corner joint brackets

With spring-loaded buttons for aluminium profiles.

## FR

### Équerre de jonction angulaire

Pour profilés d'aluminium avec des touches d'ancrage à déclic.







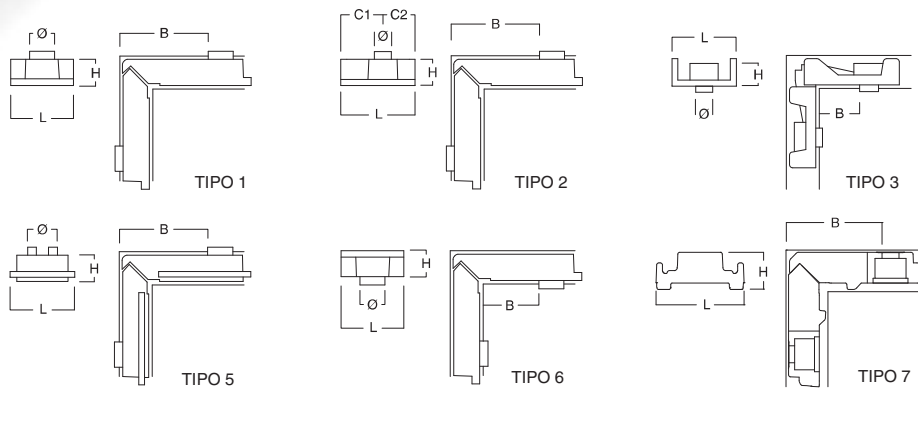











































## ES

### Esquadra de aluminio inyectado

Para perfiles en aluminio con pulsante de anclaje.



Art.	PROFILI / PROFILES / PROFILS / PERFILES	L	H	B	Ø	C1	C2	TIRAGGIO		TIPO
<b>2510</b>	ALCAN ABITHAL	25,6	10	36,5	9,5				250	1
<b>2511</b>	16 x 8,2	16	8,3	22,3	8,5				250	4
<b>2512</b>	20 x 9	19,5	8,4	38	8,5				250	1
<b>2601</b>	26,5 x 23	26	22,5	32	9,5				250	1
<b>2602</b>	26,5 x 39	26,1	38,3	32	9,5				250	1
<b>2605</b>	29,5 x 20	29	19,4	35	9,5				250	1
<b>2610</b>	27 x 10	26,2	10,4	36,5	9,5				250	1
<b>2618</b>	T.T. ALL.CO 5 / EXPORT 50 T.T. / ALCAN ABITHAL	25,5	17,4	41	9,5				250	1
<b>2618F</b>	T.T. ALL.CO 5 / EXPORT 50 T.T. / ALCAN ABITHAL	25,5	17,4	41	9,5				250	1
<b>2619</b>	24 x 26	23,8	25,8	41	9,5				250	1
<b>2620</b>	24 x 39	23,8	39	53	9,5				150	1
<b>2624</b>	38 x 16	37	15,7	41	9,5	14,6	22,4		250	2
<b>2630</b>	26,5 x 39	26	38,3	36	9,5				150	1
<b>2631</b>	22,7 x 23,5	22,2	23	36	9,5				250	6
<b>2632</b>	19,5 x 23	19	22,6	36,5	9,5				250	1
<b>2633</b>	27 x 13	26,5	12,6	36,5	9,5				250	1
<b>2634</b>	23,5 x 42	22,5	41,4	41	9,5				200	1
<b>2635</b>	ALCAN 20,5 x 36	20,3	35,7	41	9,5				200	1
<b>2636</b>	ALCAN GREEN / 30 x 40	25,2	36	41	9,5				200	1
<b>2639</b>	EKU 53 MAGG.	27	31,7	41	9,5				150	1
<b>2641</b>	36,5 x 42	35,4	41	41	9,5				100	1
<b>2642</b>	37,2 x 37	36,7	36,6	38,5	9,5				250	1
<b>2644</b>	16,5 x 23,6	16	23,3	55	8,5				250	1
<b>2650</b>	26,5 x 43	26	42,3	29,5	9,5				150	2
<b>2714</b>	27 x 14	26,5	13,8	37	9,5				250	1
<b>2714I</b>	27 x 14	26,5	13,8	22	9,5				250	6
<b>2723</b>	27,2 x 23	26,7	22,5	53	9,5				250	1
<b>2724</b>	20 x 23	19,4	22,4	53	9,5				250	1
<b>2725</b>	27 x 43	26,6	42,7	53	9,5				150	1
<b>2801</b>	GOLD	28,5	14,5	35,5	9,5				250	1
<b>2802</b>	GOLD	24	34,5	39	8				250	1
<b>2806</b>	GOLD SCORREVOLE	31,2	13,2	36					200	7

Art.	PROFILI / PROFILES / PROFILS / PERFILES	L	H	B	Ø	C1	C2	TIRAGGIO		TIPO
<b>2834</b>	GOLD	28,5	34,6	47	9,5				150	1
<b>2835</b>	PASSERINI / THERMO PORTE 68 / GOLD MAGG.	28,3	35,3	48	9,5				150	1
<b>2911</b>	28,4 x 10,7	28,4	10,7	36,5	9,5				250	1
<b>2912</b>	ALL.CO SLIDE / ALL.CO KS2 ANTA	19,5	10,5	24,5	9,5				250	4
<b>3210</b>	ALCAN POINT GREEN	32	10,4	36	9,5				250	1
<b>3218</b>	ALCAN POINT / ALCAN GREEN	32	17,5	41	9,5				250	1
<b>3218F</b>	ALCAN POINT / ALCAN GREEN	32	17,5	41	9,5				250	1
<b>3414</b>	34 x 14,4	33,7	14,3	41	9,5				250	1
<b>3415</b>	34 x 15	34	13,5	41	9,5				250	1
<b>3511</b>	35 x 11	34,5	10,6	37	9,5				250	1
<b>3515</b>	41,5 x 22,5	41,4	22,2	38	2 puls.				150	5
<b>3516</b>	41,5 x 38,5	41,4	38	38	2 puls.				100	5
<b>3522</b>	19,8 x 33,2	19,2	32,7	37,4	9,5				250	1
<b>3610</b>	SISTEMI 1	35,6	10,2	36	9,5				250	1
<b>3610.8</b>	SISTEMI 1	35,6	10,2	37	8				250	1
<b>3611</b>	36 x 10,5	36	10	36	9,5				250	1
<b>3611.8</b>	36 x 10,5	36	10	37	8				250	1
<b>4000</b>	V. I. 1080	35,9	24	41	9,5				250	1
<b>4002</b>	EXPO 40 / ALL.CO P4 / EKIP 40	36	14,7	41	9,5				250	1
<b>4002F</b>	EXPO 40 / ALL.CO P4 / EKIP 40	36	14,7	41	9,5				250	1
<b>4002MF</b>	EXPO 40 / ALL.CO P4 / EKIP 40	35,8	14,3	41	9,5				250	1
<b>4003</b>	NC 45P / NC 60T / EXPO 50	36	13,9	41	9,5				250	1
<b>4003.8</b>	NC 45P / NC 60T / EXPO 50	36	13,9	42	8				250	1
<b>4003F</b>	NC 45P / NC 60T / EXPO 50	36	13,9	41	9,5				250	1
<b>4004</b>	DOMAL 4 / OCMA MAGG.	36	29,2	41	9,5				200	1
<b>4004F</b>	DOMAL 4 / OCMA MAGG.	36	29,2	41	9,5				200	1
<b>4006</b>	NC 45P	36	13,9	41	9,5				250	1
<b>4008</b>	40 x 35	35,9	30,5	41	9,5				200	1
<b>4011</b>	40 x 29	35,9	25,8	42	9,5				200	1
<b>4014</b>	40,5 x 14,5	40	14	38	2 puls.				250	5
<b>4015</b>	FUTURA	35,9	15,4	41	9,5				250	1
<b>4015.8</b>	FUTURA	35,9	15,4	42	8				250	1
<b>4017</b>	36,5 x 20	36	19,1	41	9,5				250	1
<b>4018</b>	40 x 18	36	13,8	21	10,5				250	3
<b>4022</b>	41,5 x 12	41	11,8	41	9,5				250	3
<b>4025.8</b>	36,5 x 27,5	36	27	36	8				250	1
<b>4026</b>	33 x 18,5	32,4	18	35	9,5				250	1
<b>4028</b>	33 x 19	32,5	18,2	41	8				250	1
<b>4180</b>	40 x 18	36	13,8	21	10,5				250	3
<b>4450</b>	EKIP MAAST. OCMA	28	12	37,5	9,5				250	1
<b>4500</b>	EUROPA 5000	38,7	14,3	37	9,5				200	1
<b>4501</b>	EUROPA 4059	48	19,3	38	9,5	28,8	19,2		150	2
<b>4502</b>	EUROPA 7000	22,2	19,3	38,5	9,5				250	1
<b>4503</b>	EUROPA 7018	22	11	38,5	9,5				250	1
<b>4512</b>	EUROPA 2000 SCORREVOLE	32	14,5	37	9,5				250	1
<b>4514</b>	ALL.CO 5 / A 445 / R 40	41	10	36	9,5				250	1
<b>4515</b>	R 50 / EUROPA 500	45	15	37	9,5				200	1
<b>4516dx</b>	R 50 T.T. / NEW TECH T.T.	28,6	14	36,5	9,5	18,1	10,4		250	2
<b>4516sx</b>	R 50 T.T. / NEW TECH T.T.	28,6	14	36,5	9,5	10,4	18,1		250	2



## squadretta di spessoramento

**art. SQ04516**

Per Art. 4516dx / Art 4516sx



## ITA

### Squadrette di giunzione

Per profili in alluminio con pulsanti di tiraggio a scatto.

## EN

### Corner joint brackets

With spring-loaded buttons for aluminium profiles.

## FR

### Équerre de jonction angulaire

Pour profilés d'aluminium avec des touches d'ancrage à dé clic.

## ES

### Esquadra de aluminio inyectado

Para perfiles en aluminio con pulsante de anclaje.

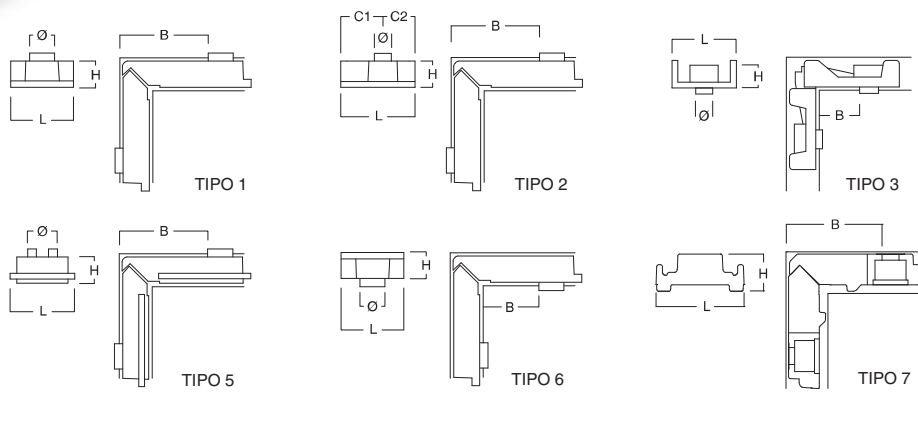

Art.	PROFILI / PROFILES / PROFILS / PERFILES	L	H	B	Ø	C1	C2	TIRAGGIO		TIPO
<b>4517</b>	R 50 SCORR. ANTA	23,9	14	41	9,5				250	1
<b>4517F</b>	R 50 SCORR. ANTA	23,9	14	41	9,5				250	1
<b>4524R</b>	50 x 22	45	21,5	41	10,5				250	1
<b>4555</b>	24 x 14	20,5	10,5	36	9,5				250	1
<b>4559</b>	SCURETTO MINI	15	8,3	37	8,5				250	1
<b>4560</b>	EXPORT 60 S / SCORR. PARIGI / ALUMEC SG 55 / ALL.CO KS2 TELAIO	24	10,5	36,5	9,5				250	1
<b>4561</b>	ALL.CO UNO / ALL.CO KS2 TELAIO	19	10,5	37,5	9,5				250	1
<b>4562</b>	NC 60 ANTA	22,5	10,5	36,5	9,5				250	1
<b>4563</b>	SKEIT ANTA	22	8,3	33	8,5				250	1
<b>4564</b>	SKEIT TELAIO	35,8	8,3	33	8,5				250	1
<b>4565</b>	32,5 x 8,5	32	8,1	33	8,5				250	1
<b>4566</b>	ALL.CO K40	22	23,5	42	9,5				250	1
<b>4567</b>	19,5 x 10,7	19	10,2	35,5	8				250	1
<b>4569</b>	22,5 x 8,5	22	8,1	21,5	9,5				250	6
<b>4700</b>	DOMAL STOPPER / ALUMEC SINT. / GOLD EKU 53	28,5	14,5	41	9,5				250	1
<b>4700F</b>	DOMAL STOPPER / ALUMEC SINT. / GOLD EKU 53	28,5	14,5	41	9,5				250	1
<b>4701</b>	TERMIC 50 / EKIP TH 68	27,8	15,8	43,5	9,5				250	1
<b>4702</b>	SCORR. METAL / SCORR. COBRA / COBRA	31	13,7	41	9,5				250	1
<b>4709</b>	DOMAL SLIDE TELAIO	51,2	14,5	41	9,5				200	1
<b>4710</b>	DOMAL BREAK	23	14	41	9,5				250	1
<b>4710F</b>	DOMAL BREAK	23	14	41	9,5				250	1
<b>4711.8</b>	14 x 22	13,7	11,8	41	8				250	1
<b>4712</b>	20 x 18	17	14,5	41	9,5				250	1
<b>4712F</b>	20 x 18	17	14,5	41	9,5				250	1
<b>4713</b>	ALCAN 20 x 17	20,3	17,3	41	9,5				250	1
<b>4714</b>	ST 45 METRA	24,6	13,6	41	9,5				250	1
<b>4715</b>	18 x 11	18	10,4	36,5	9,5				250	1
<b>4715.8</b>	18 x 11	18	10,4	37,5	8				250	1
<b>5025</b>	NC 50 x 25	45	20,5	29	10,5				200	3

# squadrette per porta

corners - équerres - esquadras



## ITA

### Squadrette di giunzione

Per profili in alluminio con pulsanti di tiraggio a scatto.

## EN

### Corner joint brackets

With spring-loaded buttons for aluminium profiles.

## FR

### Équerre de jonction angulaire

Pour profilés d'aluminium avec des touches d'ancrage à déclic.

## ES

### Esquadra de aluminio inyectado

Para perfiles en aluminio con pulsante de anclaje.

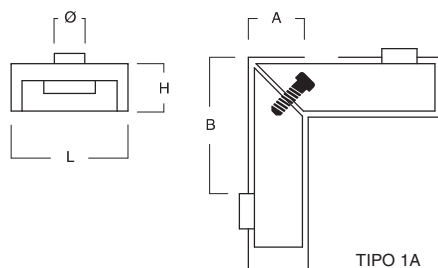

Art.	PROFILI / PROFILES / PROFILS / PERFILES	L	H	A	B	Ø	TIRAGGIO		TIPO
<b>5700</b>	HYDRO STOPPER P	33,5	35,8	52	92	10,5		50	1A
<b>5703</b>	ALCAN	31,9	35,8	52	92	10,5		50	1A
<b>5713</b>	27 x 39	27,6	38,9	52	86	8		50	1A
<b>5724</b>	36 x 36	35,6	33,5	52	86	8		50	1A

# squadrette di giunzione

corners - équerres - esquadras



## ITA

### Squadrette di giunzione

Per profili antine.

## EN

### Corner joint brackets

For aluminium profiles.

## FR

### Équerres de jonction angulaire

Pour profilés d'aluminium.

## ES

### Esquadras de empalme angular

Para perfiles en aluminio.

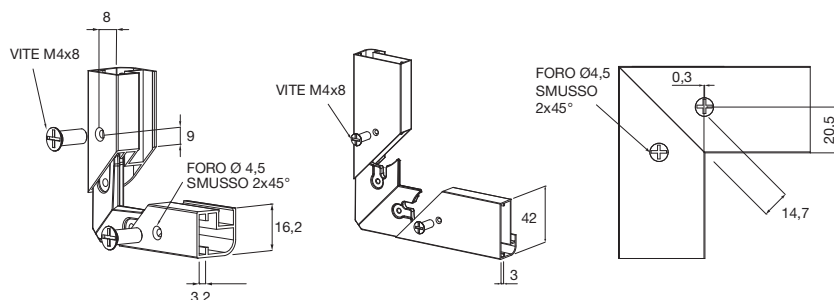

Art.	L	H	
<b>AI 100</b>	16,2	3,5	500 pz.
<b>AI 101</b>	42	3	500 pz.



### ITA

**Cavallotti in alluminio pressofuso**  
Con pulsanti di tiraggio a scatto.

### EN

**T-joints made from die-cast aluminium**  
With spring-loaded buttons.

### FR

**Embouts en aluminium fondu**  
Avec des touches d'ancrage à déclic.

### ES

**Uniones de aluminio inyectado**  
Con pulsante de anclaje.

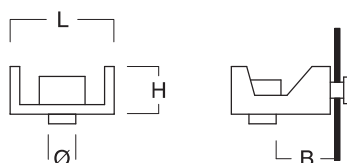

Art.	PROFILI / PROFILES / PROFILS / PERFILES	L	H	B	Ø	FILETTO		TIPO
<b>1036</b>	SISTEMA UNO	35,5	9,9	25	9,5	M6	250	1B
<b>1423</b>	DOMAL BREAK	23	14	25	9,5	M6	250	1B
<b>1426</b>	DOMAL STOPPER	26,8	14,4	36	9,5	M6	250	1B
<b>1445</b>	ALL. CO 5 / A 445 / R 40	40	10	29	9,5	M6	250	1B
<b>1725</b>	T.T. ALL. CO 5	25	17,2	25	9,5	M6	250	1B
<b>1840</b>	40 x 18	36	14	22	10,5	M6	250	1B
<b>1841</b>	40 X 18 G.A.	36	14	22	10,5	M6	250	1B
<b>2550</b>	50 x 25	45,5	20,5	30	10,5	M6	250	1B



### ITA

**Cavallotti per facciate continue.**

### EN

**T-joints for curtain walls.**

### FR

**Embouts pour jonction de façade continue.**

### ES

**Uniones para fachadas continua.**

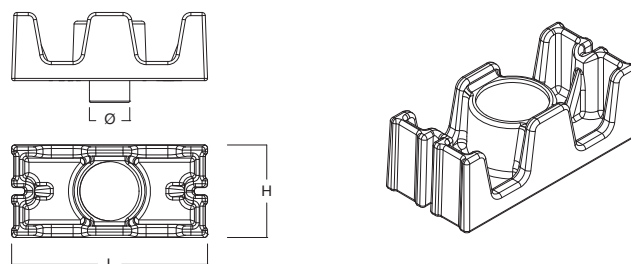

Art.	PROFILI / PROFILES / PROFILS / PERFILES	L	H	Ø		TIPO
<b>7400</b>	45,8	45,5	21,5	9,5	250	1C